

READ THIS FOR SAFE AND EFFECTIVE USE OF YOUR MEDICINE

PATIENT MEDICATION INFORMATION

PrWegovy® semaglutide injection

Read this carefully before you start taking **Wegovy®** and each time you get a refill. This leaflet is a summary and will not tell you everything about this drug. Talk to your healthcare professional about your medical condition and treatment and ask if there is any new information about **Wegovy®**.

Serious Warnings and Precautions Possible Risk of thyroid tumours, including cancer

As part of drug testing, semaglutide, the active ingredient in Wegovy® was given to rats and mice in long term studies. In these studies, semaglutide caused both rats and mice to develop medullary thyroid tumours, some of which were cancer. It is not known if semaglutide will cause thyroid tumours or a rare type of thyroid cancer called medullary thyroid cancer in people. Do not use Wegovy® if you or any of your family have ever had a type of thyroid cancer called medullary thyroid carcinoma (MTC), or if you have an endocrine system condition called Multiple Endocrine Neoplasia syndrome type 2 (MEN 2).

While taking Wegovy®, tell your doctor if you get a lump or swelling in your neck, hoarseness, trouble swallowing or shortness of breath. These may be symptoms of thyroid cancer. You should discuss any safety concerns you have about the use of Wegovy® with your doctor.

What is Wegovy® used for?

Wegovy® is used for chronic weight management in addition to reduced calorie diet and increased physical activity in adults, who have:

- a BMI of 30 kg/m² or greater (with obesity), or
- a BMI of 27 kg/m² and less than 30 kg/m² (overweight) and weight-related health problems.

**BMI (Body Mass Index) is a measure of your weight in relation to your height. See your doctor to have your BMI measured.*

Wegovy® is used for chronic weight management in addition to a reduced calorie diet and increased physical activity in adolescents aged 12 to less than 18 years, who have obesity, as diagnosed by a doctor, and who have not succeeded in weight loss with diet and exercise alone.

How does Wegovy® work?

Wegovy® is similar to a natural hormone called glucagon-like peptide-1 (GLP-1) that is released from the intestine after a meal. Wegovy® works by causing you to feel fuller and less hungry. Wegovy® should be used along with a reduced calorie diet and increased physical activity.

What are the ingredients in Wegovy®?

Medicinal ingredients: semaglutide

Single-Use Pen

Non-medicinal ingredients: Disodium phosphate dihydrate; Hydrochloric acid; Sodium Chloride; Sodium hydroxide; Water for injection

Multi-Use pen

Non-medicinal ingredients: Disodium phosphate dihydrate; Propylene glycol; Phenol; Hydrochloric acid; Sodium hydroxide; Water for injection

Wegovy® comes in the following dosage forms:

Wegovy® is supplied as a clear and colourless solution for injection in a pre-filled pen.

Wegovy® is available in a carton of 4 single-use, disposable, pre-filled pens delivering doses of either 0.25 mg, 0.5 mg, 1 mg, 1.7 mg, or 2.4 mg. The 0.25 mg, 0.5 mg and 1 mg pens contain 0.5 mL solution. The 1.7 mg and 2.4 mg pens contain 0.75 mL of solution.

Wegovy® is available in a carton of 1 multi-use, disposable, pre-filled pen delivering doses of either 0.25 mg, 0.5 mg, 1 mg, 1.7 mg, or 2.4 mg. The 0.25 mg and 0.5 mg pens contain 1.5 mL solution. The 1 mg, 1.7 mg and 2.4 mg pens contain 3 mL of solution.

Your single-use pen is only to be used once. It comes with:

- **One pre-set dose.**
- **A needle cover** that hides the built-in needle before, during and after use.
- **Automatic dosing** that starts when the needle cover is pressed against your skin as described by your healthcare professional.
-

Your multi-use pen can be used multiple times. It comes with:

- **Four doses of either 0.25 mg, 0.5 mg, 1 mg, 1.7 mg or 2.4 mg.**
- **4 disposable needles**

Do not use Wegovy® if:

- You are allergic to semaglutide or any of the other ingredients of this medicine.
- You or a member of your family has ever had medullary thyroid cancer (MTC).
- You have Multiple Endocrine Neoplasia syndrome type 2 (MEN 2).
- You are pregnant or breastfeeding.

To help avoid side effects and ensure proper use, talk to your healthcare professional before you take Wegovy®. Talk about any health conditions or problems you may have, including if you:

- or a member of your family has or has had medullary thyroid carcinoma (MTC), or if you have Multiple Endocrine Neoplasia syndrome type 2 (MEN 2).
- Have type 1 diabetes.
- Have ever had diabetic ketoacidosis (increased ketones in the blood or urine).
- Have ever had an allergic reaction to OZEMPIC® or RYBELSUS®.
- Have a high heart rate (fast pulse).
- Have ever had an inflamed pancreas (pancreatitis).
- Are breastfeeding or plan to breastfeed.
- Are pregnant or plan to become pregnant.
- Have end stage renal disease.
- Have gastrointestinal (digestive) problems, including severe vomiting, diarrhea and/or dehydration.

- Have hepatic (liver) disease.
- Have diabetic eye disease (diabetic retinopathy).
- Have heart failure.
- Have ever had gallbladder disease.
- Have ever attempted suicide, or had suicidal thoughts or depression.

Other warnings you should know about:

Children and adolescents

Wegovy® is not recommended in children and adolescents under 12 years of age or less than 60 kg (132 lbs) as the safety and efficacy in this age and weight group have not yet been studied.

Pregnancy and breastfeeding

Tell your doctor if you are pregnant, think you might be pregnant, or are planning to become pregnant. Wegovy® should not be used during pregnancy and for at least two months before a planned pregnancy because it is not known if it may affect your unborn child.

If you could become pregnant while using Wegovy®, it is recommended to use contraception.

Do not use this medicine if you are breast-feeding. This is because it is not known if Wegovy® passes into breast milk.

Driving and using machines

If you use this medicine in combination with certain diabetes medications (e.g. sulfonylurea or insulin), low blood sugar may occur which may reduce your ability to concentrate or make you feel dizzy. Avoid driving or using machines if you feel dizzy or unable to concentrate. Talk to your doctor for further information.

Severe and on-going stomach pain which could be due to inflammation of the pancreas

If you have severe and on-going pain in the stomach area – see a doctor straight away as this could be a sign of acute pancreatitis (inflamed pancreas).

Effects on the digestive system and dehydration

During treatment with Wegovy®, you may experience feeling sick (nausea) or being sick (vomiting), and diarrhea. These side effects can cause dehydration (loss of fluids). It is therefore important to drink plenty of fluids to prevent dehydration. This is especially important if you have kidney problems. Talk to your doctor if you have any questions or concerns.

Diabetic eye disease (retinopathy)

This medication may cause a temporary worsening of diabetic eye disease. If you have diabetic eye disease and experience eye or vision problems while taking this medication, talk to your doctor.

Low blood sugar (hypoglycemia)

If you are taking certain diabetes medication (e.g. sulfonylurea or insulin) when you start taking Wegovy®, this could result in low blood sugar levels. Your doctor may ask you to test your blood sugar levels. This will help your doctor decide if the dose of your diabetes medication needs to be changed.

Tell your healthcare professional about all the medicines you take, including any drugs,

vitamins, minerals, natural supplements or alternative medicines.

People with Diabetes

In particular, tell your doctor, pharmacist or nurse if you are using medicines containing any of the following:

- sulfonylurea
- insulin

Do not use Wegovy® as a substitute for insulin.

The following may interact with Wegovy®:

The following list includes some, but not all, of the drugs that may increase your heart rate. You should check with your doctor or pharmacist before taking any other medication with Wegovy®:

- Drugs to treat hypertension.
- Drugs to treat heart failure.
- Drugs to treat HIV infection.
- Drugs to treat attention deficit-hyperactivity disorder.
- Drugs to suppress appetite/cause weight loss.
- Decongestants.
- Drugs to treat asthma.

How to take Wegovy®

Wegovy® is given as an injection under the skin (subcutaneous injection). Do not inject it into a vein or muscle. The best places to give the injection are the front of your thighs, the front of your waist (abdomen), or your upper arm.

Before you use the pen for the first time, your healthcare professional will show you how to use it.

Detailed instructions for use are on the other side of this leaflet.

Always use this medicine exactly as your doctor has told you. Check with your doctor, pharmacist or nurse if you are not sure.

You should use Wegovy® once a week on the same day each week if possible. You can give yourself the injection at any time of the day – regardless of meals. To help you remember to inject Wegovy® once a week only, it is recommended to note the chosen day of the week (e.g. Wednesday) on the carton.

If necessary, you can change the day of your weekly injection of Wegovy® as long as it has been at least 3 days since your last injection of Wegovy®.

Your doctor should start you on a reduced calorie meal plan and physical activity program when you start taking Wegovy®. Stay on this program while you are taking Wegovy®.

Usual dose:

Adults

The recommended dose is 2.4 mg once weekly.

Your treatment will start at a low dose which will be gradually increased over 16 weeks of treatment.

- When you first start taking Wegovy[®], the starting dose is 0.25 mg once weekly
- Your doctor will instruct you to gradually increase your dose every 4 weeks until you reach the recommended dose of 2.4 mg once weekly.

You will be told to follow the table below.

| Dose escalation | Weekly Dose |
|------------------|-------------|
| Week 1 – 4 | 0.25 mg |
| Week 5 – 8 | 0.5 mg |
| Week 9 – 12 | 1 mg |
| Week 13 – 16 | 1.7 mg |
| Maintenance Dose | 2.4 mg |

- Once you reach the recommended dose 2.4 mg, keep using this dose. Do not increase your dose further.

Your doctor will assess your treatment on a regular basis and may tell you to change your dose if necessary.

Do not stop using this medicine without talking to your doctor.

Adolescents

For adolescents aged 12 to less than 18 years, the same dose escalation schedule as for adults should be applied (see above). Adolescents should aim at reaching the 2.4 mg maintenance dose, but can stay at a lower dose if the 2.4 mg dose cannot be reached or is not tolerated.

Overdose:

If you use more Wegovy[®] than you should, talk to your doctor straight away. You may get side effects such as feeling sick (nausea) or being sick (vomiting), or diarrhea, or hypoglycemia (dizziness, confusion, passing out).

If you think you have taken too much Wegovy[®], contact your healthcare professional, hospital emergency department or regional poison control centre immediately, even if there are no symptoms.

Missed Dose:

If you forgot to inject a dose and:

- It is 5 days or less since you should have used Wegovy[®], use it as soon as you remember. Then inject your next dose as usual on your scheduled day.
- It is more than 5 days since you should have used Wegovy[®], skip the missed dose. Then inject your next dose as usual on your scheduled day.

Do not take a double dose to make up for a missed dose.

What are possible side effects from using Wegovy[®]?

These are not all the possible side effects you may feel when taking Wegovy[®]. If you experience any side effects not listed here, contact your healthcare professional.

Like all medicines, this medicine can cause side effects, although not everybody gets them.

Very common: may affect more than 1 in 10 people

- feeling or being sick (nausea or vomiting)
- diarrhea
- constipation
- stomach pain
- feeling weak or tired
- headache
- these usually goes away over time

Common: may affect up to 1 in 10 people

- feeling dizzy
- upset stomach or indigestion
- burping
- gas (flatulence)
- bloating of the stomach
- inflamed stomach ('gastritis') – the signs include stomach-ache, feeling sick (nausea) or being sick (vomiting)
- reflux or heartburn – also called 'gastro-esophageal reflux disease'
- hair loss
- injection site reactions
- low blood sugar (hypoglycaemia) in patients with diabetes
- low blood pressure
- increase of pancreatic enzymes (such as lipase) shown in blood tests
- hemorrhoids
- change in the way food or drink tastes

The warning signs of low blood sugar may come on suddenly. They can include: cold sweat, cool pale skin, headache, fast heartbeat, feeling sick (nausea) or very hungry, changes in vision, feeling sleepy or weak, feeling nervous, anxious or confused, difficulty concentrating or shaking.

Your doctor will tell you how to treat low blood sugar and what to do if you notice these warning signs.

Low blood sugar is more likely to happen if you also take a sulfonylurea or insulin. Your doctor may reduce your dose of these medicines before you start using this medicine.

Uncommon: may affect up to 1 in 100 people

- fast heartbeat
- increase of pancreatic enzymes (such as amylase) shown in blood tests
- feeling faint or fainting/passing out
- low blood sugar (hypoglycemia) in patients without diabetes

Unknown:

- ileus (a severe form of constipation with additional symptoms such as stomach ache, bloating, vomiting etc)
- bowel obstruction
- a delay in the emptying of the stomach

| Serious side effects and what to do about them | | | |
|---|--------------------------------------|--------------|---|
| Symptom / effect | Talk to your healthcare professional | | Stop taking drug and get immediate medical help |
| | Only if severe | In all cases | |
| COMMON Patients with Type 2 Diabetes – Diabetic retinopathy complications – complications of diabetic eye disease/diabetic eye problems | | √ | |
| Gallstones Symptoms: sudden pain in the upper stomach or back, often on the right, nausea, vomiting, indigestion, or cramping | | √ | √ |
| UNCOMMON Pancreatitis (severe and ongoing pain in the stomach area which could be a sign of inflamed pancreas) | | √ | √ |
| Patients with Type 2 Diabetes – Severe hypoglycemia (low blood sugar) symptoms: feeling confused, fits and passing out | | √ | |
| Appendicitis Symptoms: sudden pain in the middle or lower right side of the abdomen, chills, fever, nausea, vomiting | | √ | √ |
| Acute kidney injury Symptoms: swelling in the legs, ankles and feet, feeling tired, confusion, shortness of breath, not enough urine | | √ | √ |
| RARE Severe allergic reaction (anaphylactic reaction, angioedema) symptoms: breathing problems, swelling of face, lips, tongue and/or throat with difficulty swallowing, and a fast heartbeat | | √ | √ |

If you have a troublesome symptom or side effect that is not listed here or becomes bad enough to interfere with your daily activities, talk to your healthcare professional.

Reporting Side Effects

You can report any suspected side effects associated with the use of health products to Health Canada by:

- Visiting the Web page on Adverse Reaction Reporting (<https://www.canada.ca/en/health-canada/services/drugs-health-products/medeffect-canada.html>) for information on how to report online, by mail or by fax; or
- Calling toll-free at 1-866-234-2345.

NOTE: Contact your health professional if you need information about how to manage your side effects. The Canada Vigilance Program does not provide medical advice.

Storage:

Keep out of reach and sight of children.

Do not use this medicine after the expiry date which is stated on the pen label and carton after 'EXP'. The expiry date refers to the last day of that month.

Keep away from the cooling element of the refrigerator. Do not freeze Wegovy® and do not use Wegovy® if it has been frozen. Protect from excessive heat and light.

Wegovy® pen is for use by one person only.

Wegovy® should not be used if it does not appear clear and colourless.

Do not dispose of any medicines via wastewater or household waste. Ask your pharmacist how to dispose of medicines you no longer use. These measures will help protect the environment.

Single-Use Pen

Store the Wegovy® single-use pen in the refrigerator at 2°C to 8°C. If needed, each single-use pen, prior to cap removal, can be kept at a temperature below 30°C for a total of 28 days.

If your pen has been exposed to light or temperatures above 30°C, has been out of the refrigerator for more than 28 days, or has been frozen, dispose of it.

Storage of Wegovy® single-use pen in the original carton is recommended until time of administration in order to protect from light.

Safely discard the Wegovy® single-use pen into a sharps disposal container after use. Do not dispose of the pen in your household trash.

Multi-Use Pen

When you are not using the pen, keep the pen cap on in order to protect from light.

Before Opening:

Store in a refrigerator (2°C – 8°C).

During Use:

You can keep the pen for 8 weeks when stored at a temperature below 30°C or in a refrigerator (2°C – 8°C).

If your pen has been exposed to temperatures above 30°C, has been out of the refrigerator for

more than 8 weeks, or has been frozen, dispose of it.

Always remove the injection needle after each injection and store the pen without a needle attached. This may prevent blocked needles, contamination, infection, leakage of solution and inaccurate dosing.

If you want more information about Wegovy®:

- Talk to your healthcare professional
- Find the full product monograph that is prepared for healthcare professionals and includes this Patient Medication Information by visiting the Health Canada website (<http://hc-sc.gc.ca/index-eng.php>); the manufacturer's website www.novonordisk.ca, or by calling 1-800-465-4334.

This leaflet was prepared by Novo Nordisk Canada Inc.

Last Revised 2024

Wegovy®, *NovoFine®*, *NovoFine® Plus* and *Novo Nordisk* are trademarks of Novo Nordisk A/S and used under license by Novo Nordisk Canada Inc.

© 2024

Novo Nordisk Canada Inc.

Instructions for Use

Wegovy® multi-use pre-filled pen (FlexTouch®)

Before using your once-weekly Wegovy® pen, **read these instructions carefully**, and talk to your doctor, nurse or pharmacist about how to inject Wegovy® correctly.

Wegovy® pen is a multi-use pen that **contains four of your prescribed doses of Wegovy®**, corresponding to four times of once-weekly use.

Please use the table on the back of the carton to keep track of how many injections you have taken and how many doses remain in your pen.

Wegovy® comes in five different strengths, each containing one of the following prescribed doses of semaglutide:

0.25 mg **0.5 mg** **1 mg** **1.7 mg** **2.4 mg**

Always start by checking your pen label to make sure that it contains your prescribed dose of Wegovy®.

Your pen is designed to be used with NovoFine® Plus or NovoFine® disposable needles up to a length of 8 mm.

The pack contains:

- Wegovy® pen
- 4 disposable needles
- Leaflet

- **Important information**

Read this Instructions for Use before you start using Wegovy®. This information does not replace talking to your healthcare provider about your medical condition or treatment.

- **Only inject one dose of Wegovy® once weekly.** If you do not take your Wegovy® as prescribed, you may not get the intended effect of this medicine.
- If you take more than one type of injectable medicine, it is very **important to check the name and dose** of your pen label **before use**.
- **Do not use this pen without help if you have poor eyesight and cannot follow these instructions.** Get help from a person with good eyesight who is trained to use the Wegovy® pen.
- Always keep pen and needles **out of sight and reach of others, especially children.**
- **Never share** your pen or your needles with other people.
- **Needles are for single use only. Never reuse your needles** as it may lead to blocked needles, contamination, infection and inaccurate dosing.
- Caregivers must **be very careful when handling used needles** to prevent accidental needle injuries and infection.

Wegovy® pen (example)

Please note: Your pen may differ in size from the pen shown in the pictures. These instructions apply to all Wegovy® pens.

Wegovy[®] pen (example)

Please Note: Your pen may differ in size from the pen shown in the pictures.

These instructions apply to all Wegovy[®] pens.

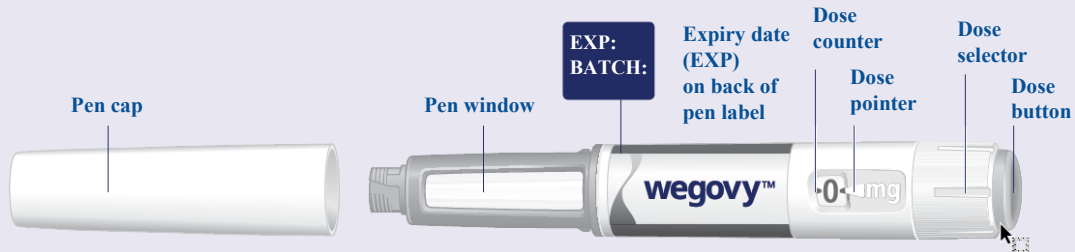

Disposable needle (example)

Disposable needle (example)

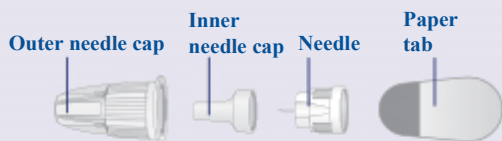

1 Prepare your pen with a new needle

Check the name and dose of your pen to make sure it contains your prescribed dose of Wegovy[®].

Pull off the pen cap.

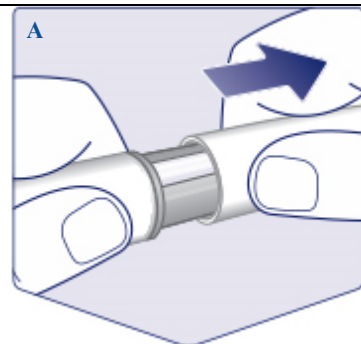

Check that the Wegovy[®] in your pen is clear and colourless. Look through the pen window. If the solution looks cloudy or coloured, do not use the pen.

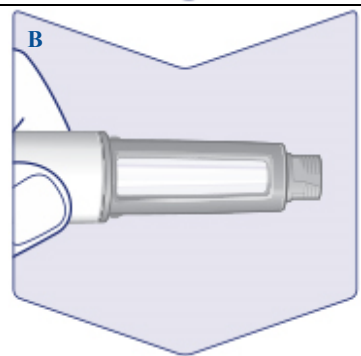

Always use a new needle for each injection.
Take a needle when you are ready to take your injection. Check the paper tab and the outer needle cap for damages. If you see any damage, this could affect sterility. Dispose of it and use a new needle.

Tear off the paper tab.

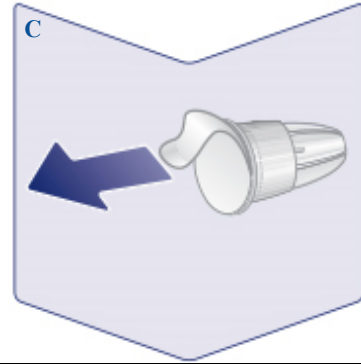

Push the needle straight onto the pen. Turn until it is on tight.

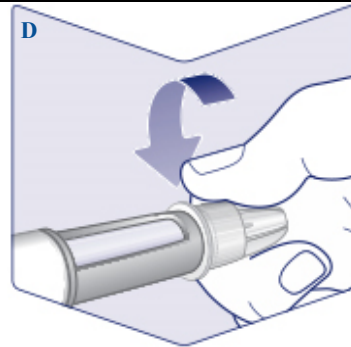

The needle is covered by two caps. You must remove both caps. If you forget to remove both caps you will not inject any medicine.

Pull off the outer needle cap and keep it for later. You will need it to safely remove the needle from the pen after the injection.

Pull off the inner needle cap and dispose of it. A drop of solution may appear at the needle tip. You must still check the flow if you use a new pen for the first time. See '**Check the flow with each new pen**'.

Never use a bent or damaged needle. For more information about needle handling, see '**About your needles**' below these instructions.

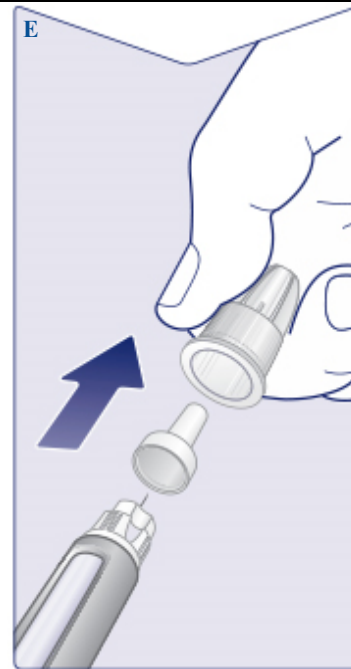

Check the flow with each new pen

If your pen is already in use, go to '**2 Set your dose**'.

Only check the flow before your **first injection with each new pen.**

Turn the dose selector until you see the flow check symbol ().



Make sure the flow check symbol lines up with the dose pointer.



Hold the pen with the needle pointing up.

Press and hold in the dose button until the dose counter returns to **0**. The **0** must line up with the dose pointer.

A drop of solution should appear at the needle tip. This drop indicates that your pen is ready for use.

If a drop does not appear, check the flow again. **This should only be done twice.**

If there is still no drop, **change the needle and check the flow once more. If a drop still does not appear**, dispose of the pen and use a new one.



2 Set your dose

Turn the dose selector until the dose counter stops, and it shows your prescribed dose.



The dashed line () in the dose counter will guide you to your dose.

The dose selector clicks differently when turned forward, backwards or past your dose. You will hear a 'click' every time you turn the dose selector. **Do not set the dose by counting the number of clicks you hear.**

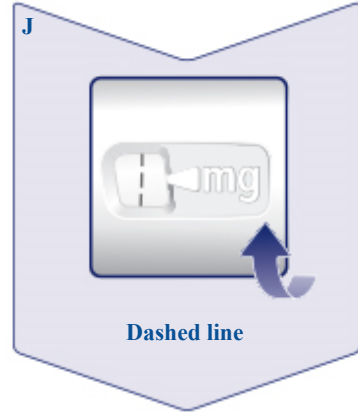

When your prescribed dose lines up with the dose pointer, you have selected your dose. In this picture, the dose **0.25 mg** is shown as an example.

If the dose counter stops before you reach your prescribed dose, see the section '**Do you have enough Wegovy®?**' below these instructions.

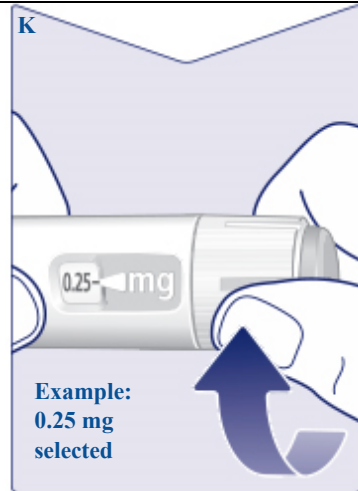

Choose your injection site

Choose upper arms, stomach or upper legs (keep a 5 cm distance from your belly button).

You may inject in the same body area each week, but make sure it is not in the same spot as used the last time.

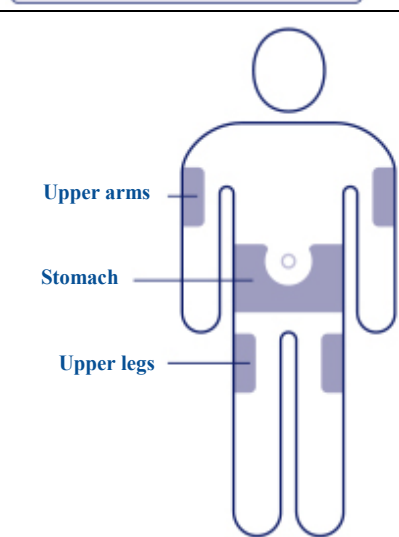

3 Inject your dose

Insert the needle into your skin as your healthcare professional has shown you.

Make sure you can see the dose counter. Do not cover it with your fingers. This could interrupt the injection.



Press and hold down the dose button until the dose counter shows 0.

Keep pressing the dose button with the needle in your skin and slowly count to 6. The 0 must line up with the dose pointer. You may hear or feel a click when the dose counter returns to 0.

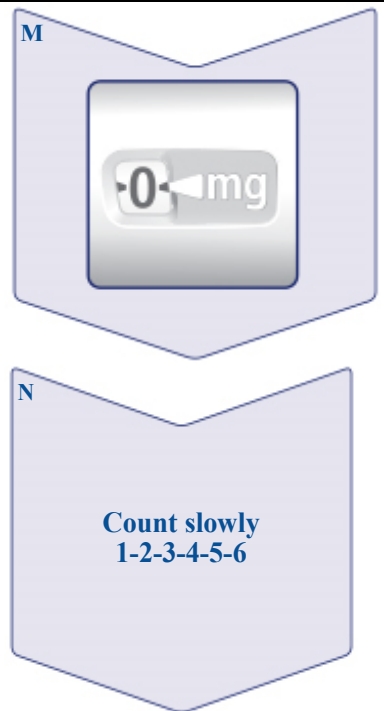

Remove the needle from your skin. If the needle is removed earlier, a stream of solution may come from the needle tip and the full dose will not be delivered.

If blood appears at the injection site, press lightly on the area to stop the bleeding.

You may see a drop of solution at the needle tip after injecting. This is normal and does not affect your dose.

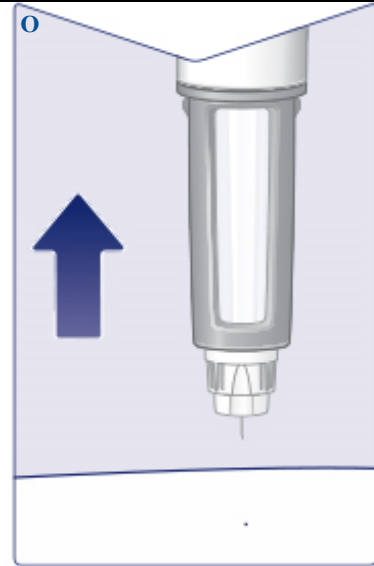

4 After your injection

Lead the needle tip into the outer needle cap on a flat surface without touching the needle or the outer needle cap.

Once the needle is covered, carefully push the outer needle cap completely on.

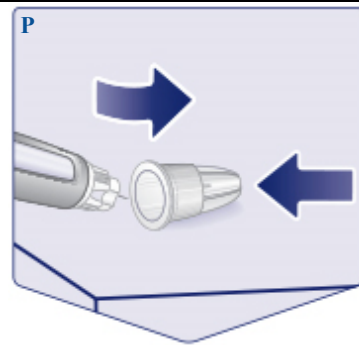

Unscrew the needle and dispose of it carefully as instructed by your doctor, nurse, pharmacist or local authorities.

Never try to put the inner needle cap back on the needle. You may stick yourself with the needle.

Always dispose of the needle immediately after each injection to prevent blocked needles, contamination, infection and inaccurate dosing. **Never store your pen with the needle attached.**

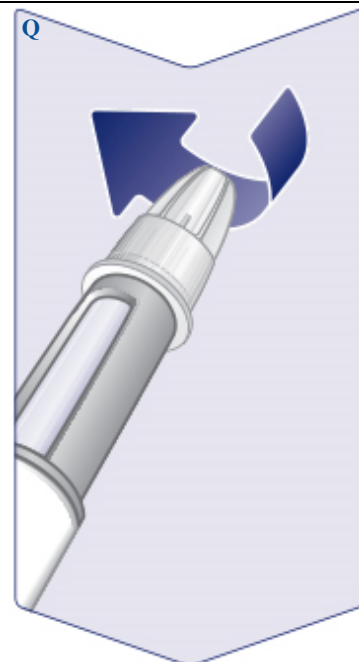

Put the pen cap on your pen after each use to protect the solution from light.

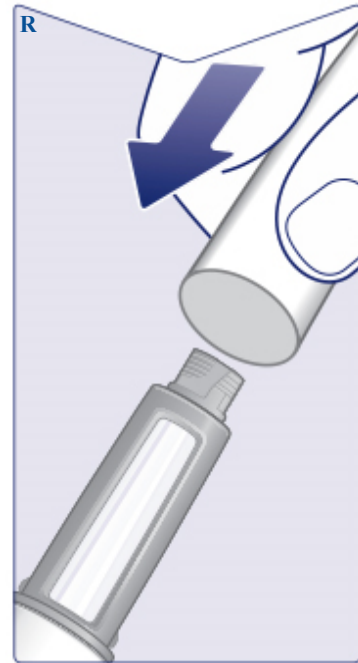

When the pen is empty, dispose of it **without** a needle on as instructed by your doctor, nurse, pharmacist or local authorities.

The pen cap and the empty carton can be disposed of in your household waste.

About your needles

How to identify a blocked or damaged needle

- If **0** does not appear in the dose counter after continuously pressing the dose button, you may have used a blocked or damaged needle.
- In this case, you have **not** received any medicine – even though the dose counter has moved from the original dose that you have set.

How to handle a blocked needle

- Change the needle as instructed in '**1 Prepare your pen with a new needle**' and go to '**2 Set your dose**'.

Caring for your pen

Treat your pen with care. Rough handling or misuse may cause inaccurate dosing. If this happens, you might not get the intended effect of Wegovy®.

- See the back of this leaflet to read the storage conditions for your pen.
- **Do not leave the pen in a car** or another place where it can get too hot or too cold.
- **Do not inject Wegovy® that has been exposed to direct sunlight.**
- **Do not subject Wegovy® to frost and never inject Wegovy® that has been frozen.** Dispose of the pen.
- **Do not drop your pen** or knock it against hard surfaces.
- **Do not try to refill your pen.** Once empty, it must be disposed of.
- **Do not try to repair your pen** or pull it apart.
- **Do not expose your pen to dust, dirt or liquid.**

- **Do not wash, soak or lubricate your pen.** If necessary, clean it with a mild detergent on a moistened cloth.

Do you have enough Wegovy®?

If the dose counter stops before you reach your prescribed dose, there is not enough medicine left for a full dose. Dispose of the pen and use a new Wegovy® pen.

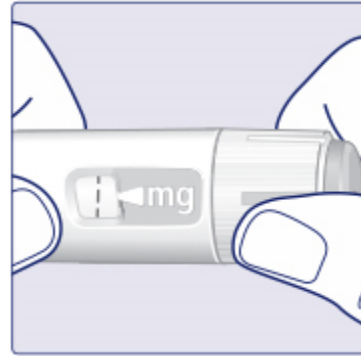

Instructions for Use

Wegovy® single-use pre-filled pen

semaglutide injection

Wegovy® comes in five strengths:

0.25 mg / 0.5 mL

0.5 mg / 0.5 mL

1 mg / 0.5 mL

1.7 mg / 0.75 mL

2.4 mg / 0.75 mL

Use Wegovy® 1 time each week



Before you use your Wegovy® pen for the first time, talk to your healthcare provider or your caregiver about how to prepare and inject Wegovy® correctly.



Pull out to get started



Important information

Read this Instructions for Use before you start using Wegovy®. This information does not replace talking to your healthcare provider about your medical condition or treatment.

- **Your Wegovy® pen is for 1 time use only.** The Wegovy® pen is for subcutaneous (under the skin) use only.
- **The dose of Wegovy® is already set on your pen.**
- **The needle is covered by the needle cover and the needle will not be seen.**
- Do not remove the pen cap until you are ready to inject.
- Do not touch or push on the needle cover. You could get a needle stick injury.
- Your Wegovy® injection will start when the needle cover is pressed firmly against your skin.
- When injecting the dose, a yellow bar will appear in the pen window.
- **Do not** remove the pen from your skin before the yellow bar in the pen window has stopped moving. If the pen is removed too early or if you have not pressed the pen firmly against the skin for the entire injection, medication may appear on the skin or squirt from the needle and you may not get your full dose of Wegovy®.
- If the yellow bar does not start moving or stops during the injection, contact your healthcare provider.
- The needle cover will lock when the pen is removed from your skin. **You cannot stop the injection and restart it later.**
- People who are blind or have vision problems should not use Wegovy® without help from a person trained to use the Wegovy® pen.

Wegovy® pen parts



How to use your Wegovy® pen

Do not use your Wegovy® pen without receiving training from your healthcare provider. Make sure that you or your caregiver know how to give an injection with the pen before you start your treatment.

Read and follow the instructions so that you use your Wegovy® pen correctly:

Preparation

Step 1. Prepare for your injection.

- **Supplies you will need to give your Wegovy® injection:** your Wegovy® pen, 1 gauze pad or cotton ball, 1 sharps disposable container for used Wegovy® pens.
- **Wash your hands.**
- **Check your Wegovy® pen.**

 Do not use your Wegovy[®] pen if:

- The pen appears to have been used or any part of the pen appears broken, for example if it has been dropped.
- The Wegovy[®] medicine looks cloudy through the pen window.
- The expiration date (Expiry) has passed.

Step 2 Choose your injection site.

- Choose your upper arms, upper legs (front of the thighs) or lower stomach (keep 2 inches away from your belly button).
- Do not inject into an area where the skin is tender, bruised, red, or hard. Avoid injecting into areas with scars or stretch marks.
- You may inject in the same body area each week, but make sure it is not in the same spot each time.

Clean the injection site. Do not touch the injection site after cleaning.

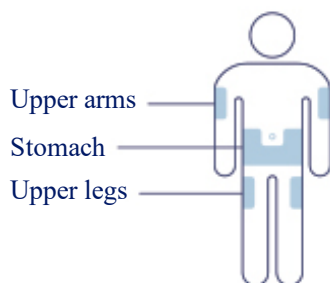

Injection

Step 3. Remove pen cap.

- Pull the pen cap straight off your pen.

Step 4. Inject Wegovy[®].

Push the pen firmly against your skin and keep applying pressure until the yellow bar has stopped moving.

- If the yellow bar does not start moving, press the pen more firmly against your skin.

What if blood appears after injection?

If blood appears at the injection site, press lightly with a gauze pad or cotton ball.



Injection

Step 3. Remove pen cap.

- Pull the pen cap straight off your pen.

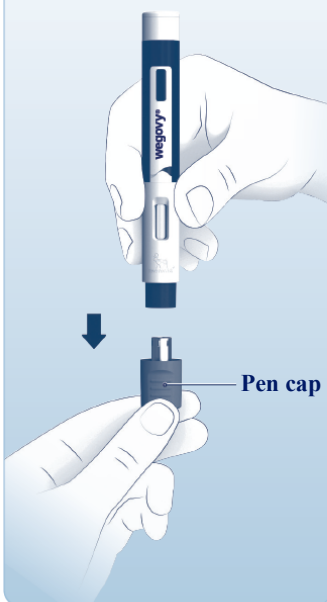

Step 4. Inject Wegovy®.

Push the pen firmly against your skin until the yellow bar has stopped moving.

- If the yellow bar does not start moving, press the pen more firmly against your skin.

What if blood appears after injection?
If blood appears at the injection site, press lightly with a gauze pad or cotton ball.



Click 1
The injection starts.

Click 2
Keep applying pressure until the yellow bar has stopped moving.

Yellow bar has stopped moving. The injection is complete.
Lift the pen slowly.

Disposal

Step 5. Dispose of pen.

Safely dispose of the pen right away after use. See “How do I throw away (dispose of) Wegovy® pens?”

i Troubleshoot

- If you experience difficulties injecting, change to a more firm injection site, such as upper leg, or upper arm or consider standing up while injecting into the lower stomach.
- If medication appears on the skin or squirts from the needle, make sure the next time you inject to keep applying pressure until the yellow bar has stopped moving. Then you can lift the pen slowly from your skin.

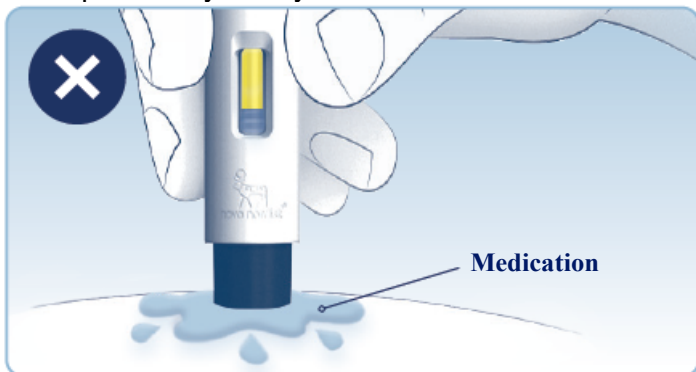

🗑️ How do I dispose of Wegovy® pens?

- Put the Wegovy® pen in a closeable, puncture-resistant sharps disposal container.
- Do not dispose of the pen in your household trash.

- Do not reuse the pen.
- Do not recycle the pen or sharps disposal container, or throw them into household trash.
- Ask your healthcare provider about options available in your area to dispose of the sharps container properly.
- The directions regarding pen handling and disposal are not intended to replace local, healthcare provider or institutional policies.
- Important: Keep your Wegovy[®] pen, sharps disposal container and all medicines out of the reach of children.

 **How do I care for my pen?**

Protect your pen

- Do not drop your pen or knock it against hard surfaces.
- Do not expose your pen to any liquids.
- If you think that your pen may be damaged, do not try to fix it. Use a new one.
- Keep the pen cap on until you are ready to inject. Your pen will no longer be sterile if you store an unused pen without the cap, if you pull the pen cap off and put it on again, or if the pen cap is missing. This could lead to an infection.

How do I store Wegovy[®]?

- Store the Wegovy[®] pen in the refrigerator between 2°C to 8°C.
- Keep Wegovy[®] in the original carton to protect it from light.
- If needed, Wegovy[®] may be stored at a temperature below 30°C in the original carton for up to 28 days.
- **Do not freeze.**
- Dispose of the pen if Wegovy[®] has been frozen, has been exposed to light or temperatures above 30°C, or has been out of the refrigerator for 28 days or longer.